

FIBER OPTIC TRANSCEIVING MODULE

TODX280A

FIBER OPTIC TRANSCEIVING
MODULE FOR DUPLEX DIGITAL
SIGNAL COMMUNICATION

- Data rate: DC to 6 Mb / s (NRZ code)
- Transmission distance: Up to 40 m
- Ceramic Package Type
- TTL interface
- LED is driven by Differential circuit.
- ATC (Automatic Threshold Control) circuit is used for stabilized output at wide range of optical power level.

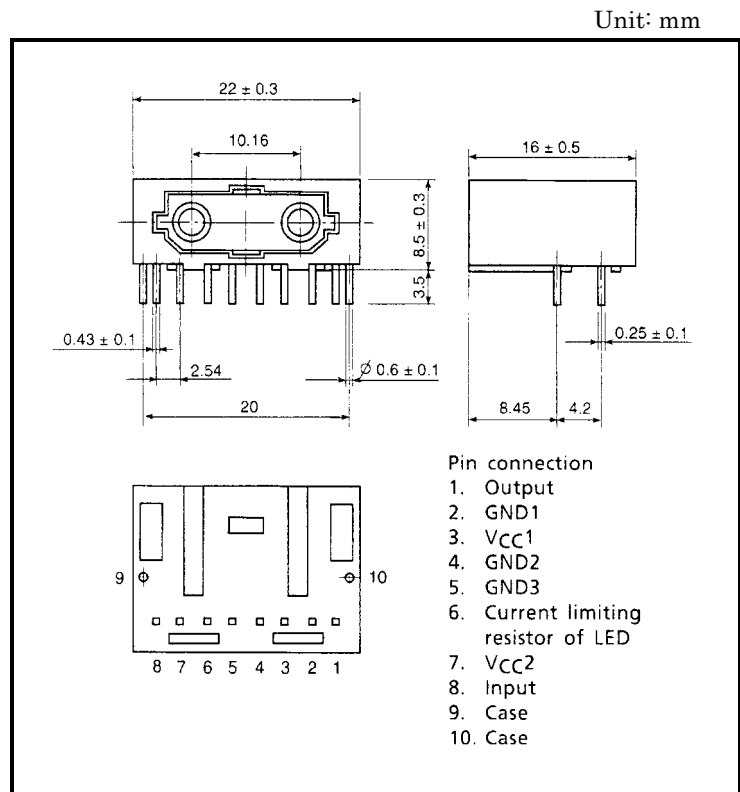

1. Maximum Ratings (Ta = 25°C)

Characteristics	Symbol	Rating	Unit
Storage Temperature	T _{stg}	-40 to 85	°C
Operating Temperature	T _{opr}	-40 to 85	°C
Supply Voltage	V _{CC}	-0.5 to 7	V
Input Voltage	V _{IN}	-0.5 to V _{CC} + 0.5	V
Low Level Output Current	I _{OL}	20	mA
High Level Output Current	I _{OH}	-1	mA
Soldering Temperature	T _{sol}	260 (Note 1)	°C

Note 1: Soldering time ≤ 3 s (More than 1 mm apart from the package).

Handling precaution: The LEDs used in this product contain GaAs (Gallium Arsenide).

Care must be taken to protect the safety of people and the environment when scrapping or terminal processing.

2. Recommended Operating Conditions

Characteristics	Symbol	Min	Typ.	Max	Unit
Supply Voltage	V_{CC}	4.75	5.0	5.25	V
High Level Input Voltage	V_{IH}	2.0	—	V_{CC}	V
Low Level Input Voltage	V_{IL}	0	—	0.8	V
High Level Output Current	I_{OH}	—	—	-60	μ A
Low Level Output Current	I_{OL}	—	—	1.2	mA

3. Electrical and Optical Characteristics (Ta = 25°C, VCC = 5 V)

Characteristics	Symbol	Test Condition	Min	Typ.	Max	Unit
Data Rate		NRZ Code (Note 2)	DC	—	6	Mb / s
Transmission Distance		Using APF (Note 3), DC to 6 Mb / s	0.2	—	40	m
Pulse Width Distortion (Note 4)	Δtw	Using TODX280A Pulse width 165 ns Pulse cycle 330 ns, $C_L = 10$ pF	-55	—	55	ns
Fiber Output Power	P_f	$R = 0 \Omega$ (Note 5)	-15	—	-9	dBm
Peak Emission Wavelength	λ_p		—	650	—	nm
Maximum Receivable Power (Note 6)	P_{MAX}	DC to 6 Mb / s, Using APF	-15	—	—	dBm
Minimum Receivable Power (Note 6)	P_{MIN}	DC to 6 Mb / s, Using APF	—	—	-27	dBm
Current Consumption	I_{CC}	$R = 0 \Omega$	—	85	115	mA
High Level Input Voltage	V_{IH}		2.0	—	—	V
Low Level Input Voltage	V_{IL}		—	—	0.8	V
High Level Input Current	I_{IH}		—	—	20	μ A
Low Level Input Current	I_{IL}		—	—	-0.4	mA
High Level Output Voltage	V_{OH}		4.6	—	—	V
Low Level Output Voltage	V_{OL}		—	—	0.4	V

Note 2: LED is on when input signal is high level, it is off when low level.

High level output when optical flux is received. Low level output when it is not received.

For data rate > 3 Mb / s, the duty factor must be kept 25 to 75%.

Note 3: All Plastic Fiber (980 / 1000 μ m).

Note 4: Between input of TODX280A and output of TODX280A.

Note 5: Measure with a standard optical fiber with fiber optic connectors. Valued by peak.

Note 6: $BER \leq 10^{-9}$, Valued by peak.

4. Example of Typical Characteristics (Note 7)

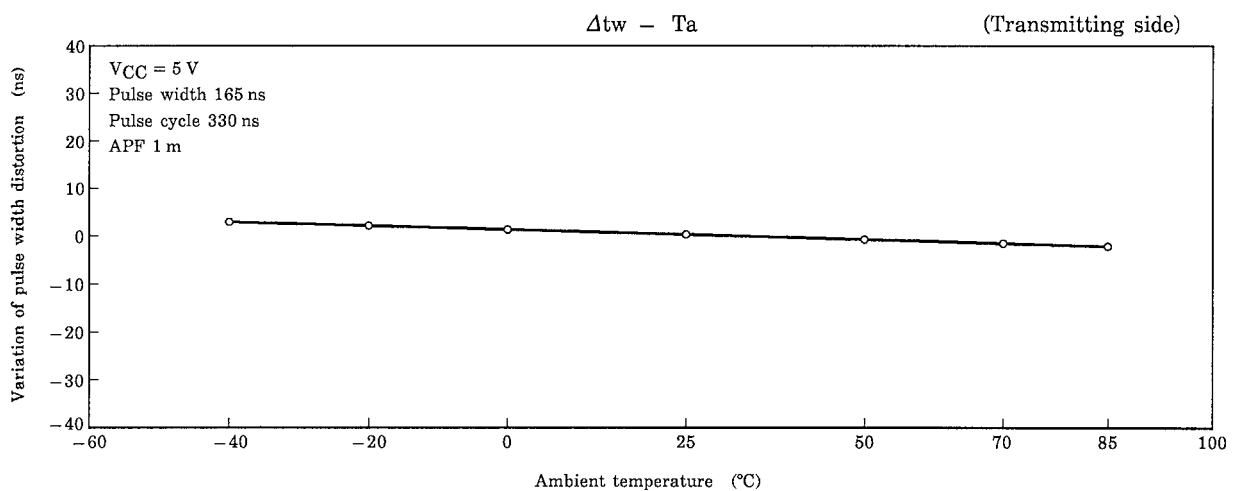
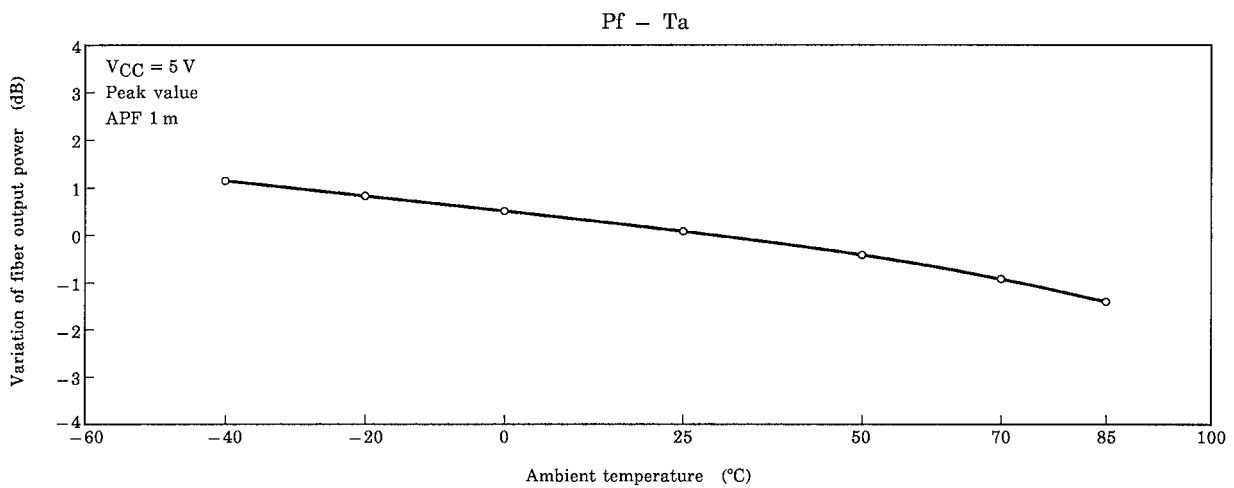
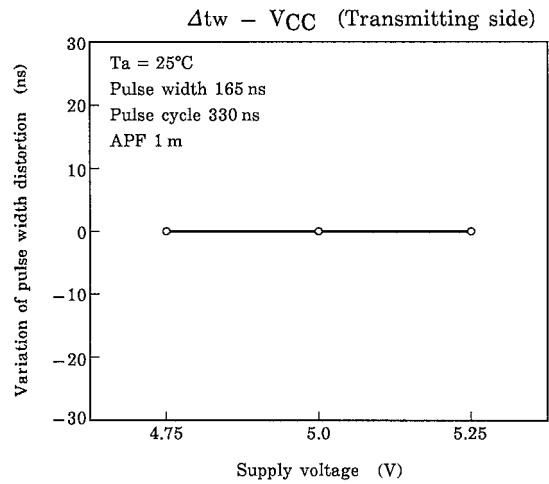
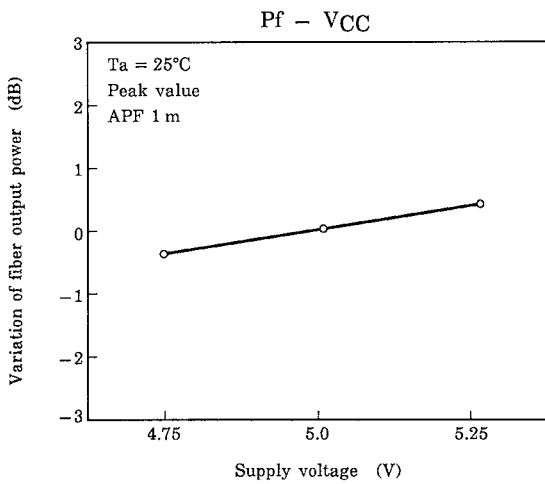

Note 7: There give characteristic examples, and its values are not guaranteed.

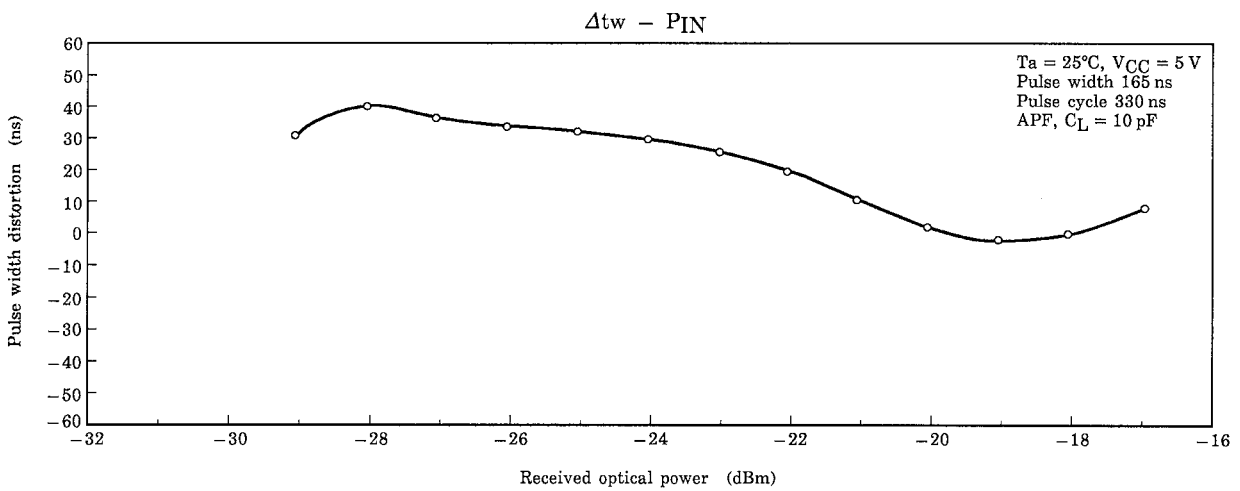
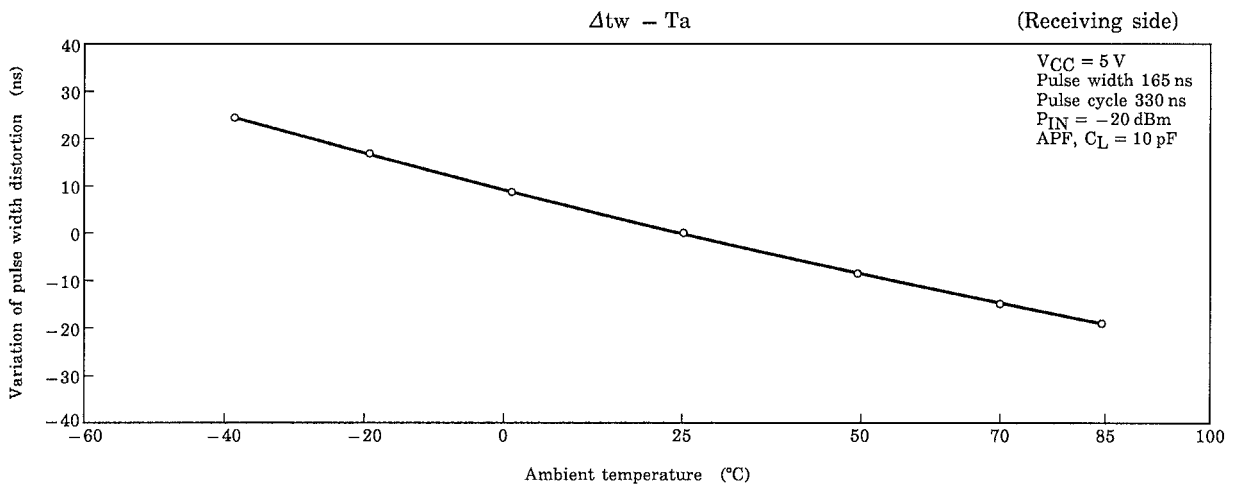
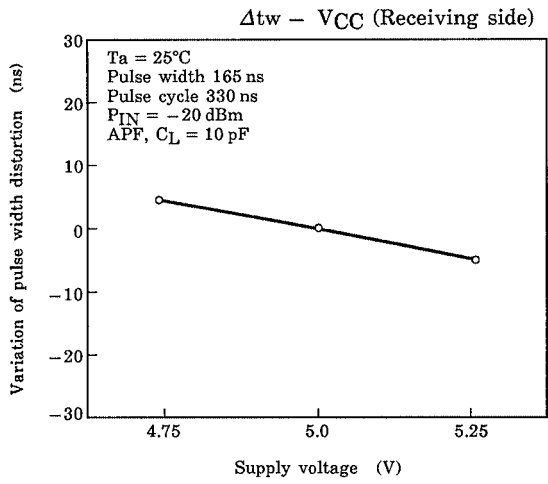

Note 7: There give characteristic examples, and its values are not guaranteed.

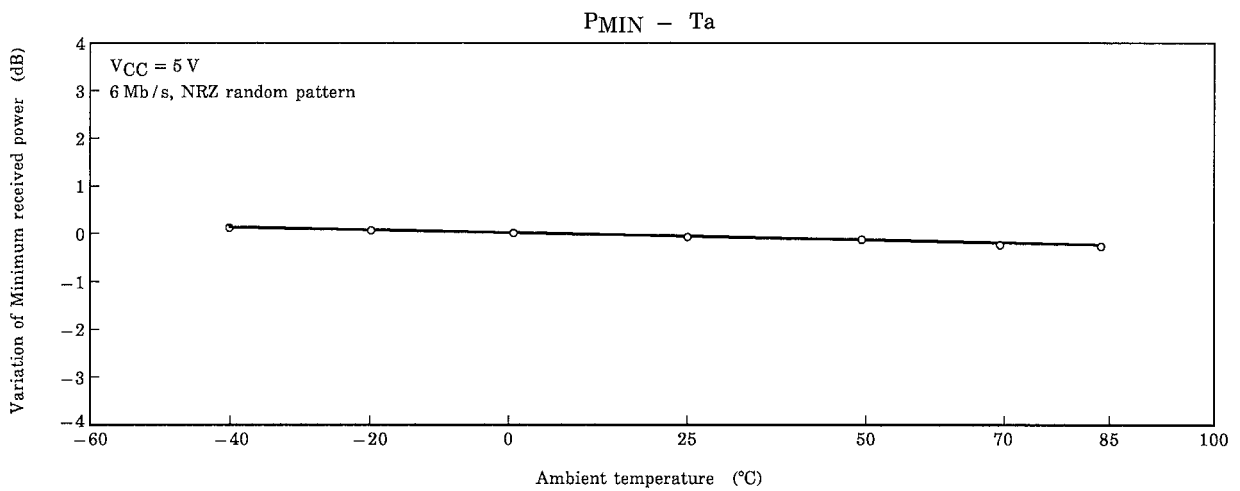
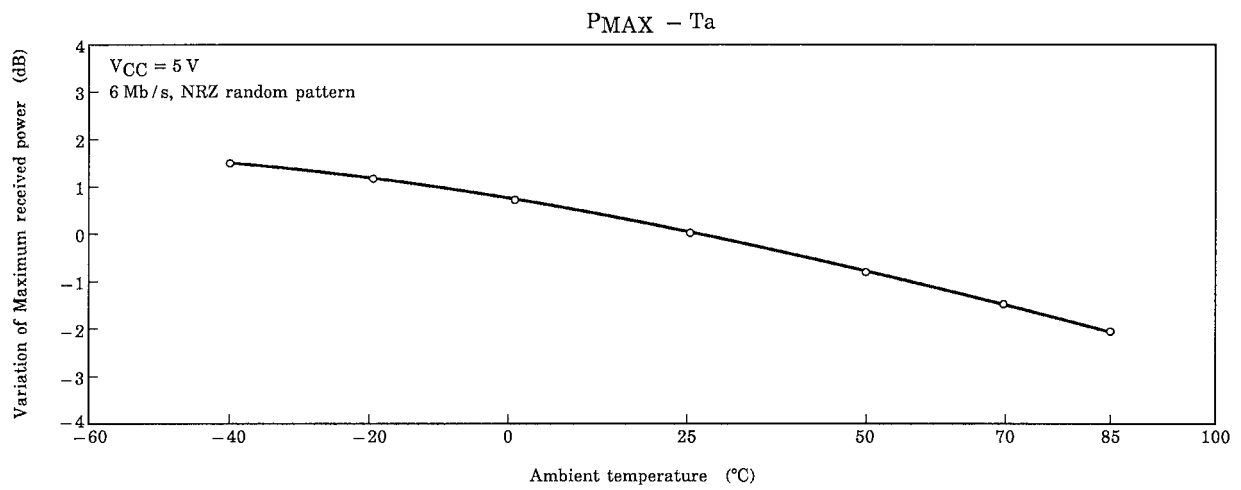
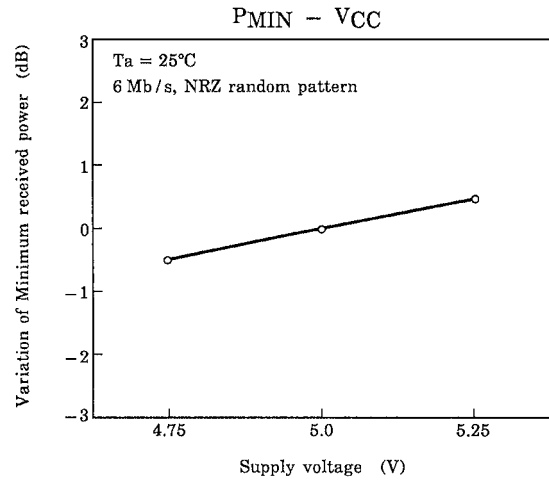
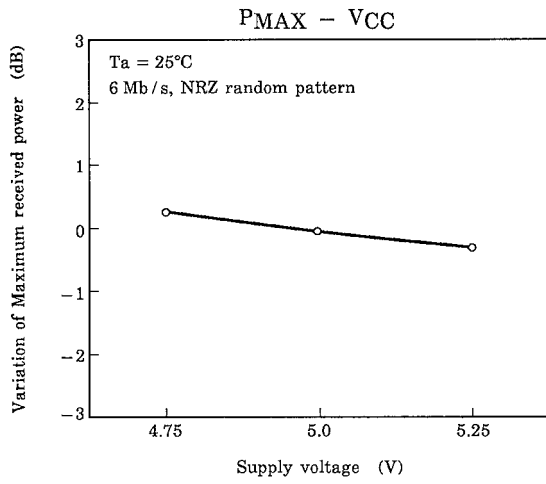

Note 7: There give characteristic examples, and its values are not guaranteed.

5. Application Circuit

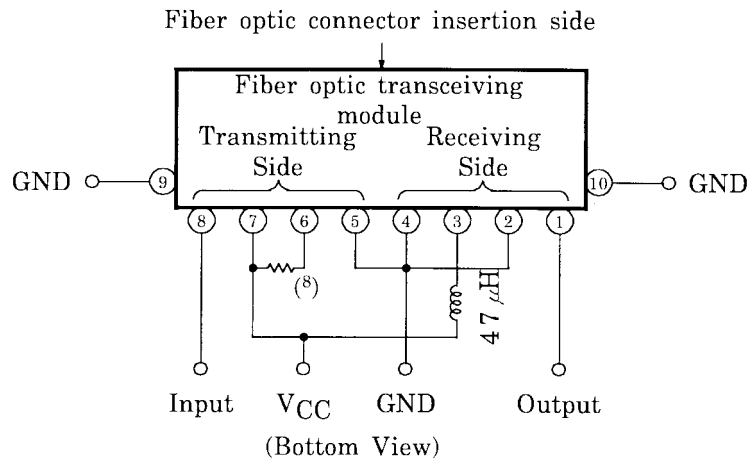

Note 8: Select a resistor value as follows:

Transmission Distance (m)	Resistor (Ω)
0.2 to 15	8.2 k
15 to 30	2.4 k
30 to 40	0

6. Applicable Optical Fiber with Fiber Optic Connectors

TOCP200-□□B, TOCP255-□□B, TOCP200P-□□B, TOCP255P-□□B

7. Precautions during use

(1) Maximum rating

The maximum ratings are the limit values which must not be exceeded during operation of device. None of these rating value must not be exceeded. If the maximum rating value is exceeded, the characteristics of devices may never be restored properly. In extreme cases, the device may be permanently damages.

(2) Lifetime of light emitters

If an optical module is used for a long period of time, degeneration in the characteristics will mostly be due to a lowering of the fiber output power (Pf). This is caused by the degradation of the optical output of the LEDs used as the light source. The cause of degradation of the optical output of the LEDs may be defects in wafer crystallization or mold resin stress. The detailed causes are, however, not clear.

The lifetime of light emitters is greatly influenced by the operating conditions and the environment in which it is used as well as by the lifetime characteristics unique to the device type. Thus, when a light emitting device and its operating conditions determined, Toshiba recommend that lifetime characteristics be checked.

Depending on the environment conditions, Toshiba recommend that maintenance such as regular checks of the amount of optical output in accordance with the condition of operating environment.

(3) Soldering

Optical modules are comprised of internal semiconductor devices. However, in principle, optical modules are optical components. During soldering, ensure that flux does not contact with the emitting surface or the detecting surface. Also ensure that proper flux removal is conducted after soldering. Some optical modules come with a protective cap. The protective cap is used to avoid malfunction when the optical module is not in use. Note that it is not dust or waterproof.

As mentioned before, optical modules are optical components. Thus, in principle, soldering where there may be flux residue and flux removal after soldering is not recommended. Toshiba recommend that soldering be performed without the optical module mounted on the board. Then, after the board has been cleaned, the optical module should be soldered on to the board manually.

If the optical module cannot be soldered manually, use non-halogen (chlorine-free) flux and make sure, without cleaning, there is no residue such as chlorine. This is one of the ways to eliminate the effects of flux. In such a cases, be sure to check the devices' reliability.

(4) Noise resistance

It is believed that the use of optical transfer devices improve noise resistance. In theory, optical fiber is not affected by noise at all. However, receiving modules which handle signals whose level is extremely small, are susceptible to noise.

TOSLINK improve noise resistance to use a conductive case. However, the current signal output by the optical receiving modules' photodiode is extremely small. Thus, in some environments, shielding the case may not achieve sufficient noise resistance.

First systems which incorporate TOSLINK, Toshiba recommend testing using the actual device to check its noise resistance.

Use a simple noise filter on TOSLINK fiber optic transceiving module's power line. If the ripple in the power supply used is significant, reinforce the filter.

The optical module is to be used in an area which is susceptible to radiated noise, increase the shielding by covering the optical module and the power line filter with a metallic cover.

(5) Vibration and shock

This module is ceramic packaged which internal device is hollow so that the wire is not fixed to the device. This structure is not relatively sound against vibration and shock. Attention must be paid to the design of the mechanism for applications which are subject to large amounts of vibration.

(6) Fixing fiber optical transceiving module

Solder the fixed pin (pins 9 and 10) of fiber optic transceiving module TODX280A to the printed circuit board to fix the module to the board.

(7) Shielding and wiring pattern of fiber optic transceiving modules

To shield, connect the fixed pins (pins 9 and 10) of fiber optic transceiving module TODX280A to the GND.

Where the fiber optic transceiving module uses conductive resin, be careful that the case does not touch wiring (including land).

To improve noise resistance, shield the optical module and the power line filter using a metallic cover.

- (8) Solvent
When using solvent for flux removal, do not use a high acid or high alkali solvent. Be careful not to pour solvent in to the optical connector ports. If solvent is inadvertently poured in to them, clean it off using cotton tips.
- (9) Protective cap
When the TODX280A is not in use, attach the protective cap.
- (10) Supply voltage
Use the supply voltage within the recommended operating condition ($V_{CC} = 5 \pm 0.25 \text{ V}$). Make sure that supply voltage does not exceed the maximum rating value of 7 V, even for an instant.
- (11) Input voltage
If a voltage exceeding the maximum rating value ($V_{CC} + 0.5 \text{ V}$) is applied to the transmitter input, the internal IC may suffer damage. If there is a possibility that excessive voltage due to surges may be added to the input terminal, insert a protective circuit.
- (12) Output
If the receiver output is at low and is connected to the power supply, or if the output is high and is connected to GND, the internal IC may be destroyed.
- (13) Soldering condition
Solder at 260°C or less for no more than three seconds.
- (14) Precautions when disposing of devices and packing materials.
When disposing devices and packing materials, follow the procedures stipulated by local regulations in order to protect the environment against contamination.
Compound semiconductors such as GaAs are used as LED materials in this module. When devices are disposed of, worker safety and protection of the environment must be taken into account.
- (15) Precautions during use
Toshiba is continually working to improve the quality and the reliability of their products. Nevertheless, semiconductor devices in general can malfunction or fail due to their inherent electrical sensitivity and their vulnerability to physical stress. It is the responsibility of the buyer, when utilizing Toshiba products, to observe standards of safety, and to avoid situations in which the malfunction or failure of a Toshiba product could cause loss of human life, bodily injury or damage to property.
When developing equipment, please ensure that Toshiba products are used within the specified operating ranges set forth in the most recent product specifications. Also, please keep in mind the precautions and conditions set forth in the Toshiba Semiconductor Reliability Handbook.

RESTRICTIONS ON PRODUCT USE

000707EAC

- TOSHIBA is continually working to improve the quality and reliability of its products. Nevertheless, semiconductor devices in general can malfunction or fail due to their inherent electrical sensitivity and vulnerability to physical stress. It is the responsibility of the buyer, when utilizing TOSHIBA products, to comply with the standards of safety in making a safe design for the entire system, and to avoid situations in which a malfunction or failure of such TOSHIBA products could cause loss of human life, bodily injury or damage to property.
In developing your designs, please ensure that TOSHIBA products are used within specified operating ranges as set forth in the most recent TOSHIBA products specifications. Also, please keep in mind the precautions and conditions set forth in the "Handling Guide for Semiconductor Devices," or "TOSHIBA Semiconductor Reliability Handbook" etc..
- The TOSHIBA products listed in this document are intended for usage in general electronics applications (computer, personal equipment, office equipment, measuring equipment, industrial robotics, domestic appliances, etc.). These TOSHIBA products are neither intended nor warranted for usage in equipment that requires extraordinarily high quality and/or reliability or a malfunction or failure of which may cause loss of human life or bodily injury ("Unintended Usage"). Unintended Usage include atomic energy control instruments, airplane or spaceship instruments, transportation instruments, traffic signal instruments, combustion control instruments, medical instruments, all types of safety devices, etc.. Unintended Usage of TOSHIBA products listed in this document shall be made at the customer's own risk.
- Gallium arsenide (GaAs) is a substance used in the products described in this document. GaAs dust and fumes are toxic. Do not break, cut or pulverize the product, or use chemicals to dissolve them. When disposing of the products, follow the appropriate regulations. Do not dispose of the products with other industrial waste or with domestic garbage.
- The information contained herein is presented only as a guide for the applications of our products. No responsibility is assumed by TOSHIBA CORPORATION for any infringements of intellectual property or other rights of the third parties which may result from its use. No license is granted by implication or otherwise under any intellectual property or other rights of TOSHIBA CORPORATION or others.
- The information contained herein is subject to change without notice.